

Interaction Notes  
Note 42

15 November 1968

Electromagnetic Scattering From  
Arbitrary Configuration of Wires

by

Clayborne D. Taylor  
Shiow-Meei Lin  
H. Val McAdams

Mississippi State University  
State College, Mississippi

ABSTRACT

A general formulation is presented for the treatment of electromagnetic scattering from an arbitrary configuration of thin wires. To illustrate the usage of the formulation, it is applied in the treatment of scattering from two perpendicular, intersecting straight wires.

## INTRODUCTION

The advent of high-speed digital computers has made possible the theoretical study of electromagnetic scattering for an arbitrary configuration of wires. If the dimensions of the wires are short in terms of the incident wavelengths, the procedure presented by Richmond<sup>1</sup> may be used. However, the general case requires new techniques and it is the purpose of this paper to present those techniques.

Coupled integral equations are derived for the currents induced in the wires with arbitrary field excitation. The number of equations is generally equal the number of wires. If the wires intersect, it is found that additional boundary conditions must be employed, in particular, a "Kirchhoff Circuit Law" condition and the continuity of scalar potential. With the boundary conditions and the reduction of the coupled integral equations to a system of linear equations (following the procedure outlined by Aronson and Taylor<sup>2</sup>), the formulation is in suitable form for programming a digital computer.

Knowing the induced current distribution it becomes a relatively simple matter to compute the back scattered fields<sup>1</sup>. Hence one may then compute back scattering cross-sections of practically any configuration of wires. This has immediate application to radar return studies for various types of radar chaff.

Also the presented formulation may be applied to the numerical investigation of a number of complex antenna structures; for example, the L-antenna, the T-antenna, the Turnstile antenna, and various antenna arrays. To illustrate the usage of the presented formulation it is applied in the treatment of electromagnetic scattering from two perpendicular, intersecting straight wires. Extensive numerical data are obtained and discussed.

## ANALYSIS

### Derivation of System of Integral Equations

According to the considerations of thin wire scattering theory<sup>3,4,5</sup> the tangential component of the vector potential at the surface of the n th wire in proximity to a system of  $N$  arbitrarily oriented current carrying wires is

$$A_{sn}(S_n) = \frac{\mu}{4\pi} \sum_{m=1}^N \int_{L_m} dS'_m (\hat{S}'_m \cdot \hat{S}_n) I_m(S'_m) G_m(S_n, S'_m) \quad (1)$$

where

$$G_m(S_n, S'_m) = \exp \left[ -jk \sqrt{r^2(S_n, S'_m) + a_m^2} \right] / \sqrt{r^2(S_n, S'_m) + a_m^2}$$

$I_m(S'_m)$  is the total axial current at point  $S'_m$  on m th wire

$\hat{S}'_m$  is the unit vector tangential to the m th wire at point  $S'_m$

$L_m$  is the arc length at m th wire

$r(S_n, S'_m)$  is the linear distance as shown in Figure 1.

In the foregoing the harmonic time dependence,  $\exp(j\omega t)$ , is assumed but suppressed. The usual scalar potential is

$$\phi_n(S_n) = j \frac{r}{4\pi k} \sum_{m=1}^N \int_{L_m} dS'_m \frac{d}{dS'_m} I_m(S'_m) G_m(S_n, S'_m) \quad (2)$$

At the surface of each wire the tangential component of the electric field is set equal zero. That is, for the n th wire

$$E_{sn}(S_n) + E_{sn}^i(S_n) = 0$$

where  $E_s^i$  is the tangential component of the incident electric field and

$E_s$  is the tangential component of the scattered field. It is well known

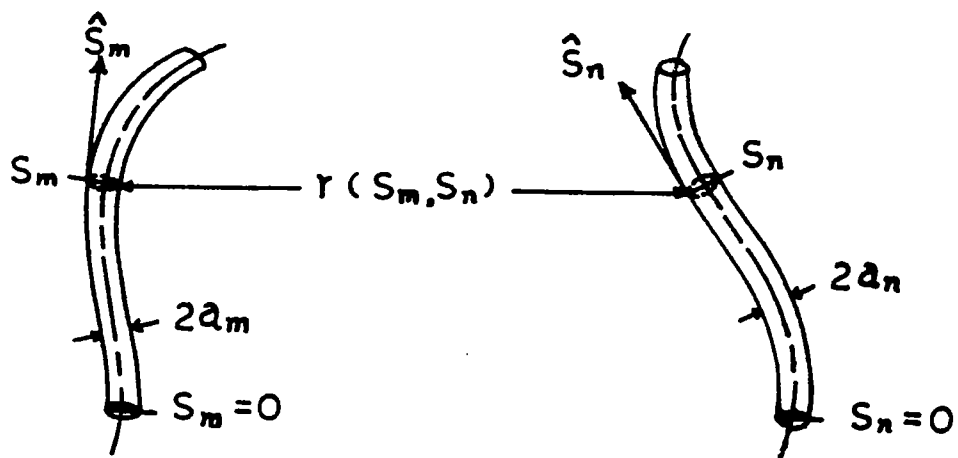

Figure 1: Two arbitrarily oriented wires

that

$$E_{sn}(S_n) = -\nabla_{sn} \phi_n(S_n) - j\omega A_{sn}(S_n) \quad (4)$$

$$-E_{sn}^i(S_n) = -\frac{d}{dS_n} \phi_n(S_n) - j\omega A_{sn}(S_n) \quad (5)$$

The substitution of (1) and (2) into (5) yields a system of integro-differential equations for the current distributions induced in the wires by the incident (or impressed) electromagnetic fields. However the system does not yield unique solutions for the induced currents without the application of appropriate boundary conditions.

Rather than working with integro-differential equations, it is convenient to reduce the system to integral equations. This may be accomplished by defining the scalar function.

$$\bar{\Phi}_n(S_n) = -\frac{jk^2}{\omega} \int_0^{S_n} dS'_n \phi_n(S'_n) \quad (6)$$

By using (6) in (5) yields

$$\left[ \frac{d}{dS_n^2} + k^2 \right] \bar{\Phi}_n(S_n) = k^2 \left[ \bar{\Phi}_n(S_n) - A_{sn}(S_n) \right] - \frac{jk^2}{\omega} E_{sn}^i(S_n) \quad (7)$$

The formal solution of the foregoing differential equation is

$$\begin{aligned} \bar{\Phi}_n(S_n) = & C_n \cos k S_n + D_n \sin k S_n \\ & + k \int_0^{S_n} dS'_n \left[ \bar{\Phi}_n(S'_n) - A_{sn}(S'_n) \right] \sin k(S_n - S'_n) \\ & - \frac{jk}{\omega} \int_0^{S_n} dS'_n E_{sn}^i(S'_n) \sin k(S_n - S'_n) \end{aligned} \quad (8)$$

Since  $\bar{\Phi}_n(0) = 0$ ,  $C_n = 0$ . The first integral on the right hand side of (8) may be combined with  $\bar{\Phi}_n(S_n)$  to yield the system of equations\*

\*Essentially all the mathematical manipulations required to obtain (9) are presented by Mei<sup>3</sup> in his treatment of the single wire antenna problem.

$$\sum_{n=1}^N \int_{L_n} dS'_n I_n(S'_n) \Pi(S_m, S'_n) = C_m \cos kS_m + D_m \sin kS_m - j \frac{4\pi}{\xi} \int_0^{S_m} dS'_m E_{sn}^i(S'_m) \sin k(S_m - S'_m) \quad (9)$$

$$\text{where } \Pi(S_m, S'_n) = G(S_m, S'_n) \hat{S}_m \cdot \hat{S}'_n - \int_0^{S_m} dS'_m \left[ \frac{\partial}{\partial S'_m} G(S'_m, S'_m) (\hat{S}'_m \cdot \hat{S}'_n) + \frac{\partial}{\partial S'_n} G(S'_m, S'_n) + G(S'_m, S'_n) \frac{\partial}{\partial S'_m} (\hat{S}'_m \cdot \hat{S}'_n) \right] \cos k(S_m - S'_m) \quad (10)$$

In deriving (9) it was required that the current vanish at the wire ends. Of course, this boundary condition could not strictly be applied to wires without free ends. The constants  $C_m$  and  $D_m$  must be determined from boundary conditions.

#### Boundary Conditions

If the system of  $N$  wires does not have intersecting wires then the appropriate boundary conditions are

$$I_n(S_n) \Big|_{\text{wire ends}} = 0 \quad n = 1, 2, \dots, N$$

In the juncture of wires two physical processes must obtain. Firstly there should be no charge accumulation at the juncture. That is, the total electric current into the juncture is equal the current out of the juncture; this may be recognized as a paraphrase of the Kirchhoff circuit law. Secondly mutual points on the wires at the juncture must be at the same potential. This is an enforcement of the continuity of scalar potential.

Perhaps a cursory investigation of the scattering problem would not reveal the necessity of additional boundary conditions when there are intersecting wires. However, it is feasible to have a geometrical configuration that allows exchange of charge between the wires at the juncture.

Obviously in this case, the current distribution on a given wire must be discontinuous across the junction. This effectively adds an additional unknown (the magnitude of the discontinuity) for each wire. But the implementation of the foregoing boundary conditions will yield a sufficient number of independent equations to obtain these additional unknowns.

The implementation of the first boundary condition (no charge buildup at junctions) is quite simple. Unfortunately the enforcement of continuity of scalar potential is not quite as simple. According to the assumption of electrically thin wires the current distributions, scalar potentials, and vector potentials are constant about the periphery of the wire. Therefore the continuity of scalar potential is enforced only at the axial points locating the junctions.

To illustrate the application of the boundary conditions consider that all  $N$  wires of a system of  $N$  wires intersect at one point that this point is located by  $l_n$  for the  $n$  th wire. The first boundary condition (no charge buildup) yields

$$\lim_{\delta \rightarrow 0} \sum_{n=1}^N \left[ I_n(l_n + \delta) - I_n(l_n - \delta) \right] = 0 \quad (11)$$

Since (2) yields

$$\phi_n(S_n) = \frac{-j\omega}{4\pi k} \sum_{m=1}^N \int_{\alpha}^{S_m} dS'_m I_m(S'_m) \frac{\partial}{\partial S'_m} G_m(S_n, S'_m) \quad (12)$$

The enforcement of scalar potential yields

$$\phi_1(l_1) = \phi_n(l_n) \quad n = 2, 3, \dots, N \quad (13)$$

Because the coordinates on each wire are defined relative to an arbitrary point, it is possible to choose coordinates such that  $l_n = 0$ ,  $n = 1, 2, \dots, N$ .

In this case (13) yields very simple results. From (6)

$$\phi_n(S_n) = j \frac{\omega}{k^2} \frac{d}{dS_n} \bar{\Phi}_n(S_n) \quad (14)$$

and using the foregoing in (8) yields

$$\begin{aligned} \phi(S_n) = j \frac{\omega}{k} D_n \cos kS_n + j\omega \int_0^{S_n} dS'_n [\bar{\Phi}_n(S'_n) - A_{sn}(S'_n)] \\ \times \cos k(S_n - S'_n) + \int_0^{S_n} dS'_n E_{sn}^1(S'_n) \cos k(S_n - S'_n) \quad (15) \end{aligned}$$

Substituting (15) into (13) requiring  $\ell_n = 0$  one obtains

$$D_1 = D_n \quad n = 2, 3, \dots, N \quad (16)$$

Note that application of the boundary conditions at a junction of wires yields  $N$  equations for  $N$  intersecting wires while  $N$  intersecting wires introduces  $N$  additional unknowns. Therefore a unique solution is obtained.

#### Numerical Solution

The system of integral equations presented in (9) may be solved by the so-called direct integration technique. For an excellent formal discussion of this technique see Harrington<sup>4</sup> and for a discussion of the practical aspects see Aronson and Taylor<sup>2</sup>. Basically the direct integration technique reduces the system of linear integral equations to a system of linear algebraic equations that may be solved by use of a high speed digital computer. The numerical results of an application of the presented formulation have been obtained and will be presented subsequently.



### Short-Wire Configurations

In his treatment of electromagnetic scattering from wire-grid objects, Richmond<sup>1</sup> was able to ignore the boundary conditions at intersections of wires. The wire-grid objects were considered to be formed by segments of wires short in length as compared to the wavelength of incident radiation. Although Richmond's formulation is admittedly approximate (for example, the boundary condition on the tangential electric field is not fully satisfied and a uniform current distribution is assumed for each wire segment) his results exhibit good agreement with the experimental data that is presented. But in general the neglect of boundary conditions on the current distribution can not always be expected to lead to satisfactory results, particularly since it does not insure a unique solution. To illustrate the difficulty that may be encountered consider that Richmond's technique is applied to a single straight wire. The result would be a "direct integration" solution to Pocklington's integral equation for the current distribution induced on the wire. However Mei<sup>3</sup> shows that the "direct integration" solution to Pocklington's equation yields a spurious result. But it must be pointed out that Richmond restricted his formulation to short-wire segments that form a grid or a loop (in which case there are no boundary conditions on the current distribution) so that the current distribution on the wires is essentially uniform. Within the stated limits Richmond's formulation yields good results.

## NUMERICAL RESULTS

To obtain numerical results, a simple configuration of wires is selected for treatment. Only two straight wires which intersect perpendicularly are considered (see Figure 2). The horizontal wire is oriented symmetrically about the vertical wire. For this configuration (9) yields the following system of integral equations.

$$\int_{-\ell_1}^{\ell_2} dz' I_1(z') K_1(z-z') + \int_{-\ell_3}^{\ell_3} dx' I_2(x') K_2(x',z) =$$

$$C_1 \cos kz + D_1 \sin kz - j \frac{4\pi}{\zeta} \int_0^z dz' E_{1z}^1(z') \sin k(z-z') \quad (17)$$

$$\int_{-\ell_1}^{\ell_2} dz' I_1(z') K_2(z',x) + \int_{-\ell_3}^{\ell_3} dx' I_2(x') K_1(x-x') =$$

$$C_2 \cos kx + D_2 \sin kx - j \frac{4\pi}{\zeta} \int_0^x dx' E_{2x}^1(x') \sin k(x-x') \quad (18)$$

where

$$K_1(z-z') = \exp \left[ -jk \sqrt{(z-z')^2 + a^2} \right] \sqrt{(z-z')^2 + a^2} \quad (19)$$

$$K_2(x',z) = \int_0^z dz' \frac{\partial}{\partial x'} \left[ \sqrt{x'^2 + z'^2 + a^2} \right] \cos k(z-z') \quad (20)$$

$I_1(z)$  is the current distribution on the vertical wire and  $I_2(x)$  is the current distribution on the horizontal wire. According to Figure 2, the origin of the coordinate system appears at the intersection of the wires so that (16) applies. Then

$$D_1 = D_2 \quad (21)$$

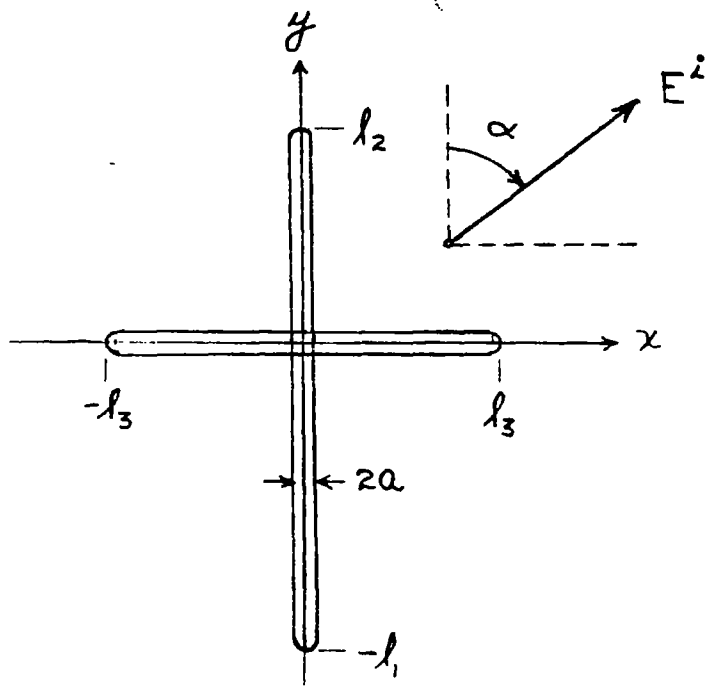

Figure 2: Two intersecting-perpendicular wires with the incident electric field.

The other boundary condition needed is

$$\lim_{S \rightarrow 0} I_1(S) - I_1(-S) + I_2(S) - I_2(-S) = 0 \quad (22)$$

With (21) and (22) it should be possible to obtain unique solutions for currents,  $I_1(z)$  and  $I_2(x)$ , induced in the wires by the incident field components,  $E_{1z}^i(z)$  and  $E_{2x}^i(x)$ .

For convenience the crossed wire configuration is considered to be illuminated by a plane wave propagating normally to the plane of the wires. In this case

$$\left. \begin{aligned} E_{1z}^i(z) &= E_o \cos \alpha \\ E_{2x}^i(x) &= E_o \sin \alpha \end{aligned} \right\} \quad (23)$$

where  $E_o$  is the magnitude of the electric field considered directed at an angle  $\alpha$  with the  $z$  axis. For the data that are presented subsequently  $E_o = 1$  volt/meter.

The system of integral equations is solved using the aforementioned numerical solution technique. A fortran program was written for the IBM 360 Model 40 computer and the approximate running time of the program for this "not exceedingly fast" computer is about 10 minutes.

Whenever the intersection of the wires is at their respective midpoints, it is found that there is no coupling present, i.e. the currents induced in the wires are the same as would be induced in the respective wires alone. The effect of coupling between the wires is most clearly demonstrated in figure 3. Here the real and imaginary parts of the current distribution on the horizontal elements are shown. Since  $\alpha = 0$  the current induced on the horizontal elements is solely due to the coupling and because of this

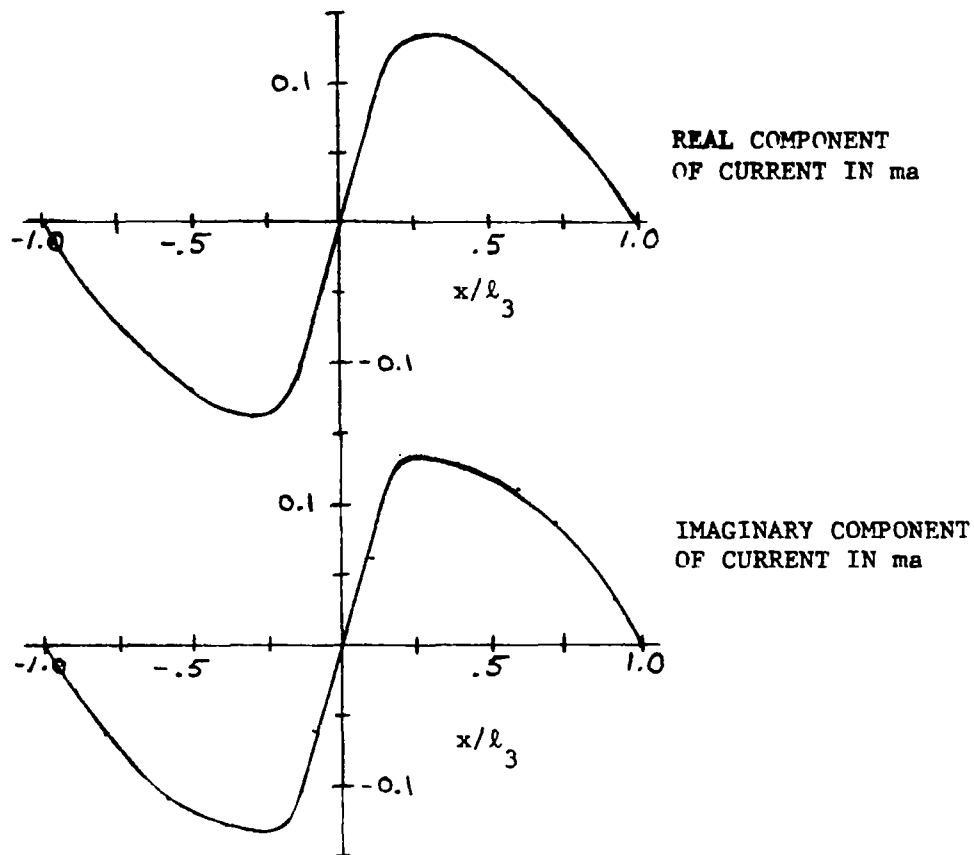

Figure 3: Current distribution on the horizontal element  
 for  $\Omega = 2 \ln [(\ell_1 + \ell_2)/a] = 10.0$ ,  $\alpha = 0^\circ$ ,  $k\ell_1 = 1.38$ ,  
 $\ell_2 = \ell_1/2$ ,  $\ell_3 = \ell_1/2$ .

the current distribution is antisymmetric. For the same parameters, figure 4 shows the real and imaginary parts of the vertical current distributions. It is seen that the field induced current on the vertical element is about one order of magnitude greater than the coupling induced current on the horizontal element. An interesting note on both sets of curves is that the current distribution on the respective wires are continuous across the intersections. At least this is observed to be the case to within the accuracy of the numerical results.

In figures 5, 6 and 7 the frequency dependence is shown for the current at the center of the vertical element. Since there is no coupling when  $l_1 = l_2$ , it is seen that the coupling slightly affects the center currents.

A knowledge of the currents induced in the wires allows a ready determination of the various scattering cross sections (for the definitions see reference [4]). The bistatic cross section is shown in figure 9 where the transmitting antenna transmits a signal propagating normally to the plane of wires and is linearly polarized with angle of polarization  $\alpha$ . The receiver dipole lies in the plane containing the z axis and perpendicular to the xz plane. The angle  $\beta$  is the angle between the axis of the received dipole and the z axis. The angle  $\theta$  is the angle between the positive z axis and the direction to the receiver. Again the effects of the coupling of the wires are demonstrated in figure 10 and 11 where the total cross section and the monostatic cross sections are plotted versus the electrical length of the vertical element.

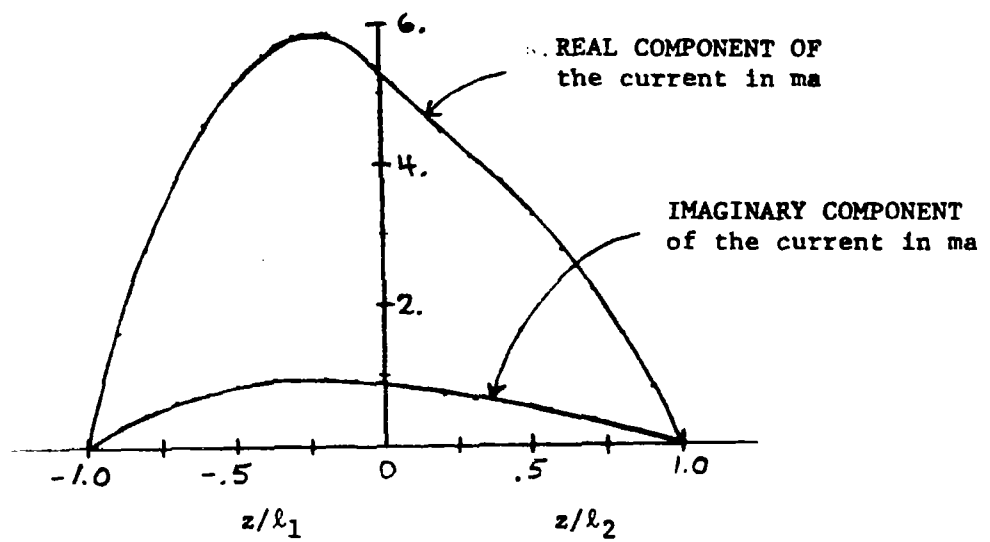

Figure 4: Current distribution on the vertical element for  $\Omega = 2\pi \left[ (\ell_1 + \ell_2)/a \right] = 10.0$ ,  $\alpha = 0^\circ$ ,  $k\ell_1 = 1.38$ ,  $\ell_2 = \ell_1/2$ ,  $\ell_3 = \ell_1/2$

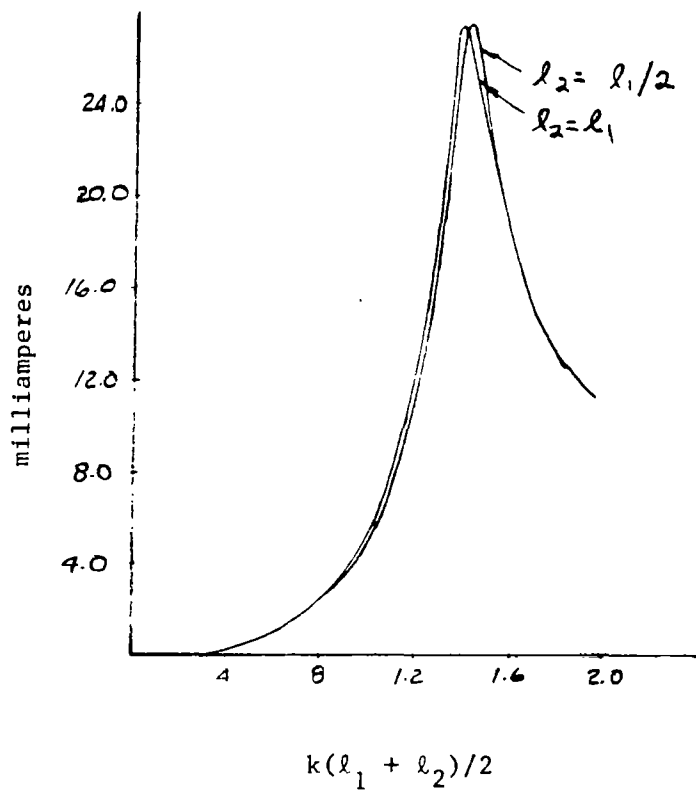

Figure 5: Real component of the center current on the vertical wire versus the electrical half-length.  
 $\Omega = 2 \ln[(l_1 + l_2)/a] = 10.0$ ,  $\alpha = 0^\circ$ ,  $l_3 = l_1/2$



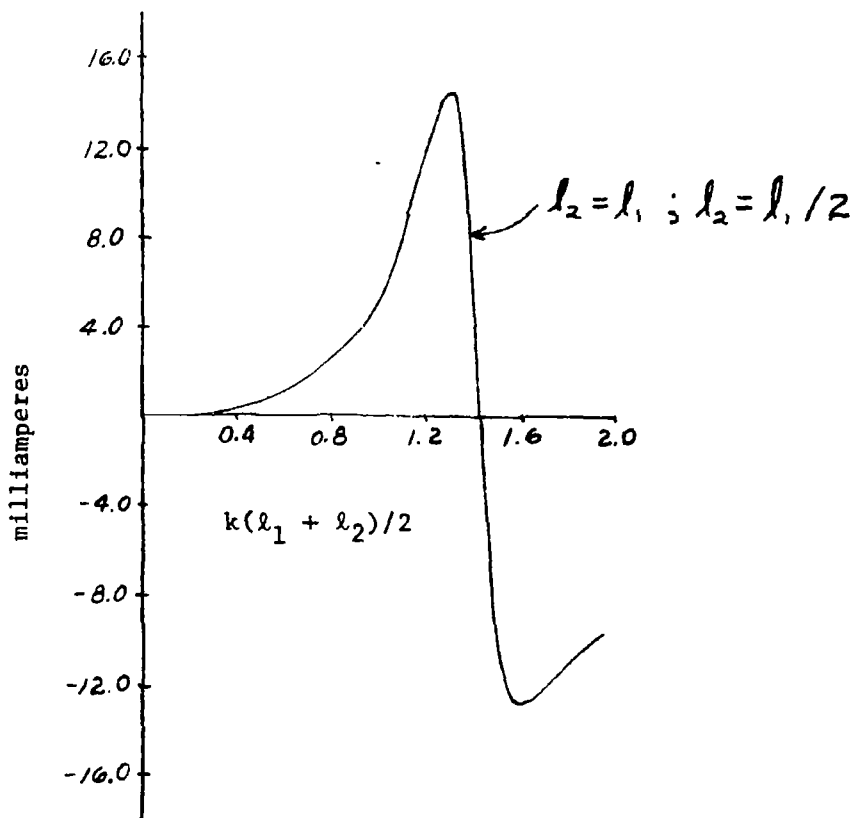

Figure 6: Imaginary component of the center current on the vertical wire versus the electrical half-length.  $\Omega = 2 \ln \left[ \frac{l_1 + l_2}{a} \right] = 10.0$ ,  $\alpha = 0^\circ$ ,  $l_3 = l_1/2$

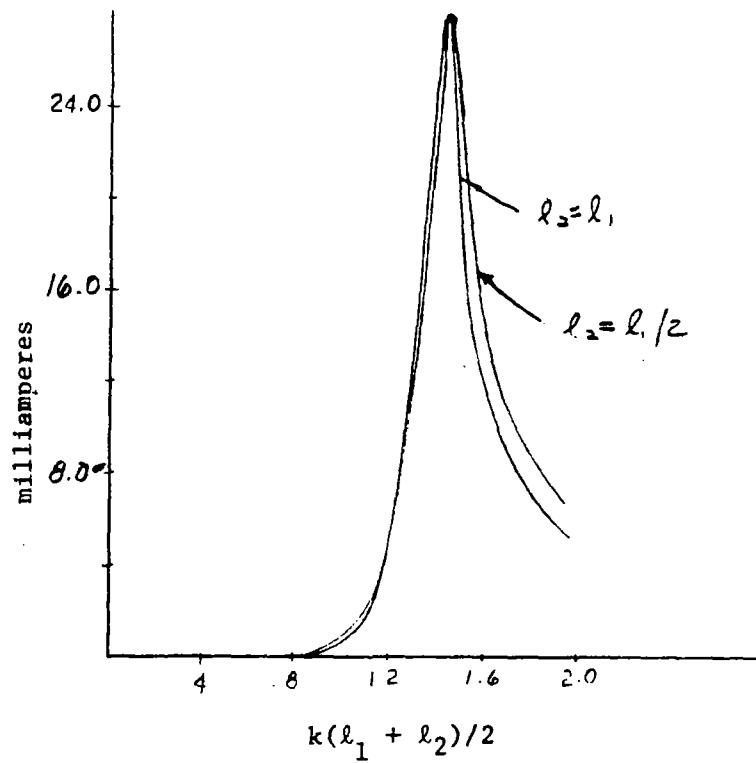

Figure 7: Magnitude of the center on the vertical wire versus the electrical half-length.  $\Omega = 2 \ln \left[ \frac{l_1 + l_2}{2} \right] = 10.0$ ,  $\alpha = 0^\circ$ ,  $l_3 = l_1/2$

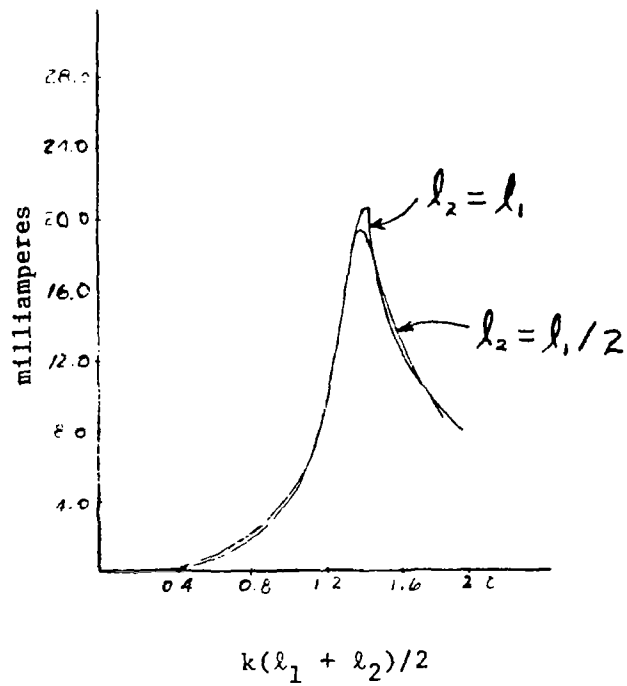

Figure 8: Magnitude of the center current on the vertical wire versus the electrical half-length.  $\Omega = 2 \ln [(l_1 + l_2)/a] = 10.0$ ,  $\alpha = 45^\circ$ ,  $l_3 = l_1/2$

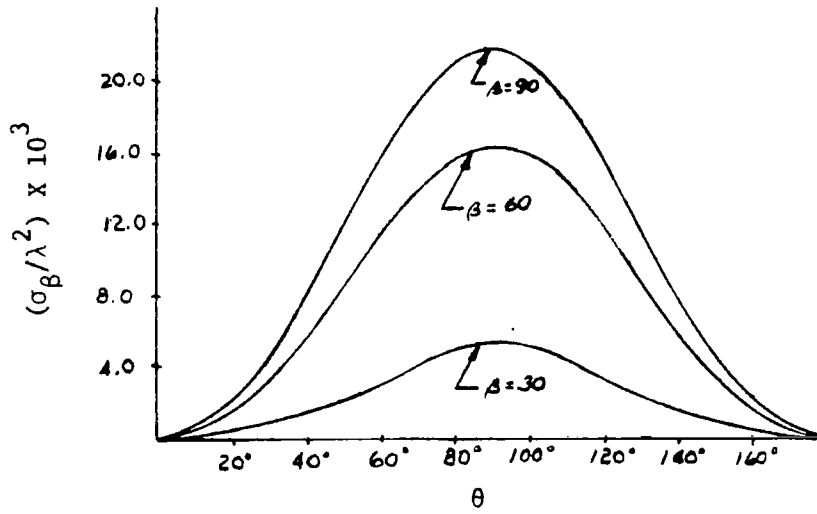

Figure 9: Bistatic cross section versus polar angle to receiver.  
 $\Omega = 2 \ln \left[ \frac{(l_1 + l_2)}{a} \right] = 10.0, l_3 = l_1/2, \alpha = 45^\circ$

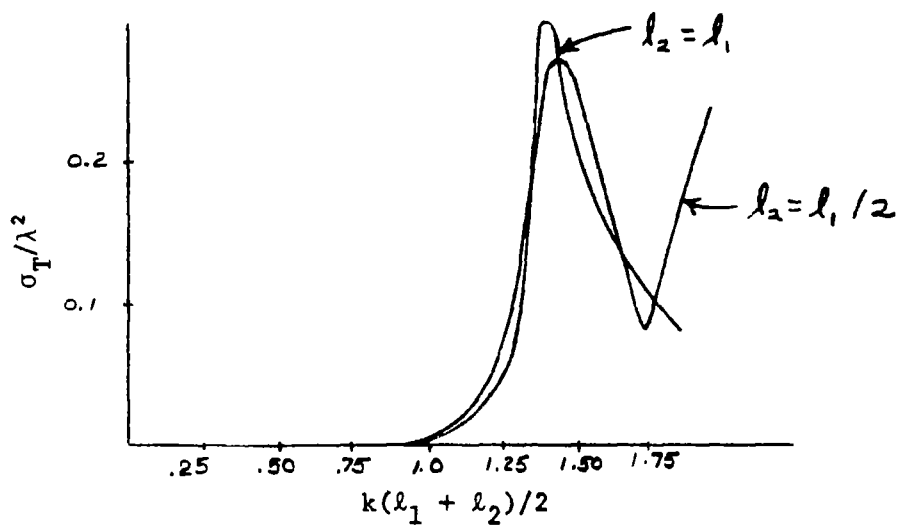

Figure 10: Total scattering cross section versus electrical half-length of vertical wire.  $\Omega = 2\ln[(l_1 + l_2)/a] = 10.0$ ,  $l_3 = l_1/2$ ,  $\alpha = 45^\circ$

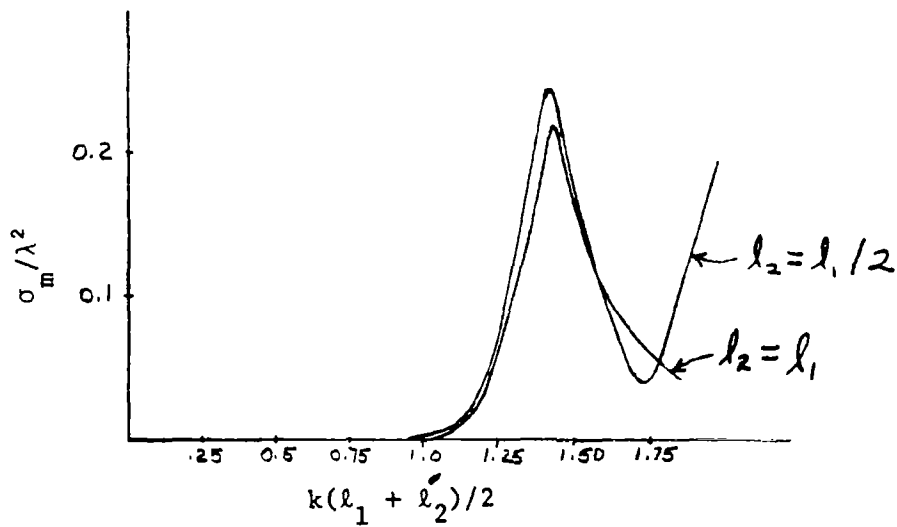

Figure 11: Monostatic cross section versus electric half-length of vertical wire.  $\Omega = 2 \ln \left[ \frac{l_1 + l_2}{a} \right] = 10.0$   
 $l_3 = l_1 / 2, \alpha = 45^\circ$ .

## CONCLUSION

A very general formulation is presented which may be applied in principle to the treatment of scattering from any configuration of wires. The application is only limited by the capability of the available high-speed digital computer. Basically the formulation provides a system of coupled linear integral equations to be solved for the induced current distribution subject to certain boundary conditions. The system of integral equations may be solved by the "direct integration" technique that reduces the system to linear algebraic equations.

## REFERENCES

1. J. H. Richmond, "A Wire-Grid Model for Scattering by Conducting Bodies," IEEE Trans. Ant. Prop., Vol AP-14, No. 6, pp 782-784 (November 1966).
2. E. A. Aronson and C. D. Taylor, "Matrix Methods for Solving Antenna Problems," IEEE Trans. Ant. Prop., Vol AP-15, No. 5, pp 696-697, (September, 1967).
3. K. K. Mei, "On the Integral Equations of Thin Wire Antennas," IEEE Trans. Ant. Prop., Vol. AP-13, No. 3, pp. 374-378, (May 1965).
4. R. F. Harrington, "Matrix Methods for Field Problems, Proc. IEEE, Vol. 55, No. 2, pp. 136-149, (February 1967).
5. C. H. Tang, "Input Impedance of Arc Antennas and Short Helical Radiators," IEEE Trans. Ant. Prop. Vol. AP-12, No. 1, pp 2-9, (January 1964).